



RoHS  
Compliant

Level-1 Controlled Substances are banned

技术要求

- 1、插拔力: 3.0KGF Max
- 2、接触电阻:  $\leq 30m\Omega$
- 3、绝缘电阻:  $>100M\Omega$  DC 250V
- 4、耐电压: 500V
- 5、寿命: 5000 10~20次/min
- 6、额定负载: DC 20V 10A
- 7、适用温度范围:  $-25 \sim 85^\circ C$
- 8、电镀要求: 外壳全镀50u/min, 接触针芯镀金1u/min
- 9、塑胶材质: LCP UL 94-V0 黑色
- 10、端子: 铜2680

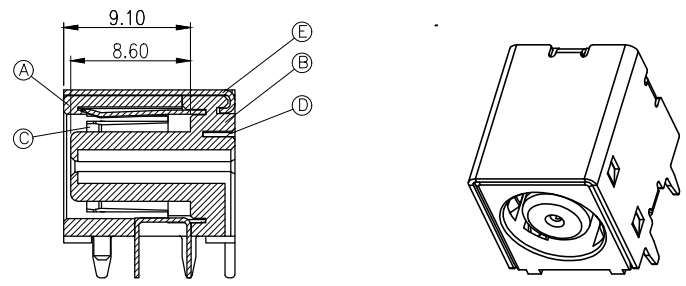

SECTION A-A  
SCALE 1:1

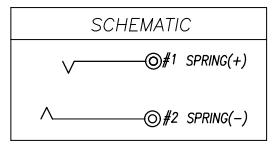
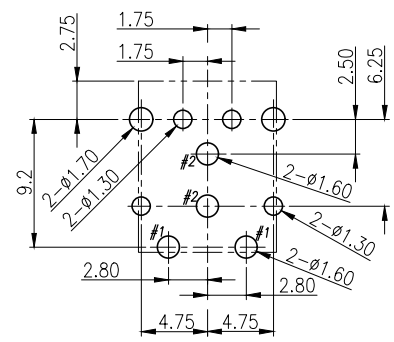
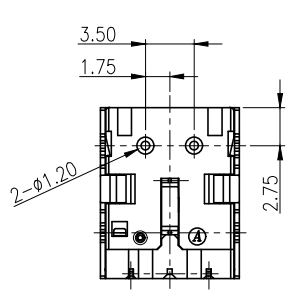
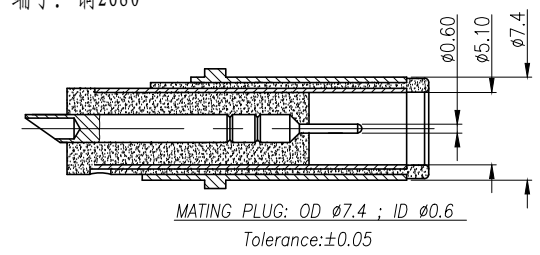
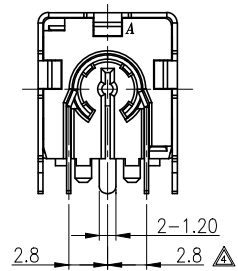
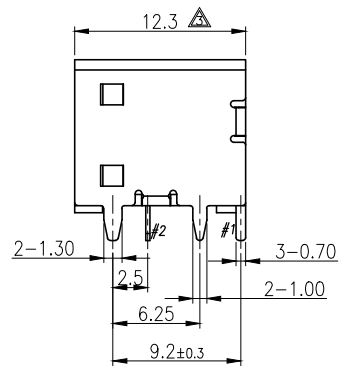
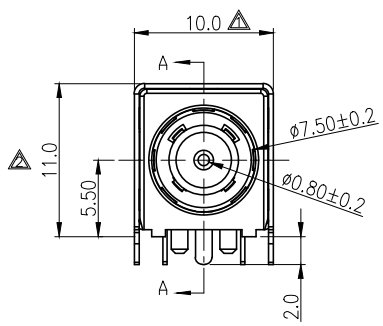
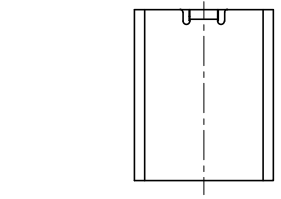
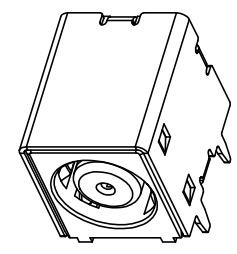

E	SHELL	1	BRASS 0.35T		Ni 50u"Min
D	CONTACT (+)	1	COPPER ALLOY 0.3T		GOLD FLASH OVER Ni 50u"
C	SPRING (-)	1	COPPER ALLOY 0.3T		GOLD FLASH OVER Ni 50u"
B	COVER	1	HIGH TEMP. THERMOPLASTIC	BLACK	UL 94V-0
A	HOUSING	1	HIGH TEMP. THERMOPLASTIC	BLACK	UL 94V-0

NO.	DESCRIPTION	QTY	MATERIAL	COLOR	REMARK		
GENERAL TOLERANCE UNLESS OTHERWISE SPECIFIED			深圳市鑫南天科技有限公司 Shen zhen Shi Xin Nan Tian Industrial Co., Ltd				
General		Angle				CUSTOMER COPY	
X	±0.50	X				± 3°	TITLE: DC-JACK
XX	±0.30	XX				± 2°	PART NO. XNT-DC-102
XXX	±0.10	XXX				± 1°	
PROJ:		SCALE: 1:1	UNIT:mm	SIZE: A4	SHEET: 1 OF 1		

DESIGN	Jason	16'/06/03			
CHECK	Jason	16'/06/03			
APPRO.	Max.hu	16'/06/03			
ECN(DCN) NO.	REV	DATE	DESCRIPTION	CHANGE	APPRO.
	0	16'/06/03	NEW	JASON	Max.hu

Original:Design: Jason Check: Jason Appro:Max.hu Date:16'/06/03